





Stepper



 Montascale per il trasporto di persone disabili su carrozzina, particolarmente silenzioso e versatile. L'alimentazione di rete (230V) e la dotazione di batterie da 24V lo rende la soluzione ideale per il basso impegno di corrente. Il funzionamento del montascale è assicurato anche in assenza di energia elettrica. I movimenti di pedana, bracciolo e bandella sono automatici, inoltre l'assenza di cremagliera favorisce un buon risultato estetico.

 **Stepper** is a stairlift platform for the transportation of persons with reduced mobility in a wheelchair. Characterized by a particularly smooth and quiet operation. The power source 230V and the 24v battery supply makes **Stepper** the ideal solution for a low energy consumption. The functioning of the stairlift is assured even in the event of a power failure. The movements of the platform, safety arms and ramps are fully automatic. The absence of a rack operated system gives a better aesthetic result.

 Salvaescaleras para el transporte de personas discapacitadas en silla de ruedas, muy silencioso y versátil. La alimentación de red eléctrica (230V) y la dotación de baterías de 24V lo convierten en la solución ideal para la baja potencia necesaria. El funcionamiento del salvaescaleras está garantizado también en ausencia de energía eléctrica. Peana, brazo de seguridad y bandejas son motorizados, además la ausencia de cremallera favorece un buen resultado estético.

 Monte-escalier pour le transport de personnes handicapés en fauteuil roulant, particulièrement silencieux et polyvalent. L'alimentation (230V) et la fourniture de batteries à 24V le rend idéal pour le faible engagement de puissance. Le fonctionnement de monte-escalier est assuré même en l'absence d'énergie électrique. Les mouvements de la plate-forme, accoudoir et bande sont automatiques, également l'absence de la grille favorise un bon résultat esthétique.

 Der **Stepper**-Treppenlift ist ein System zum Befördern von alten Menschen oder Menschen mit Behinderungen. Das Stromnetz (230V) und die Ausrüstung von Batterien 24V macht es ideal für den geringen Stromverbrauch. Besondere Aufmerksamkeit wurde dem Fahrkomfort zugewendet: leiser Betrieb, erleichterte Umgänglichkeit und ein besonders weicher Vorschub machen **Stepper** für jede Art Treppe geeignet.

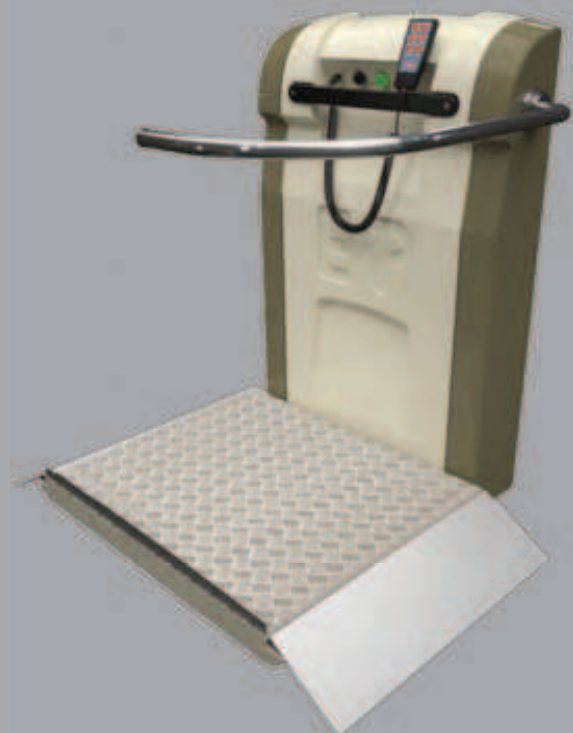



Stepper



Automatic

Automatic

Automatic



wall remote control
(optional)



remote control
(standard)

on-board control
(standard)



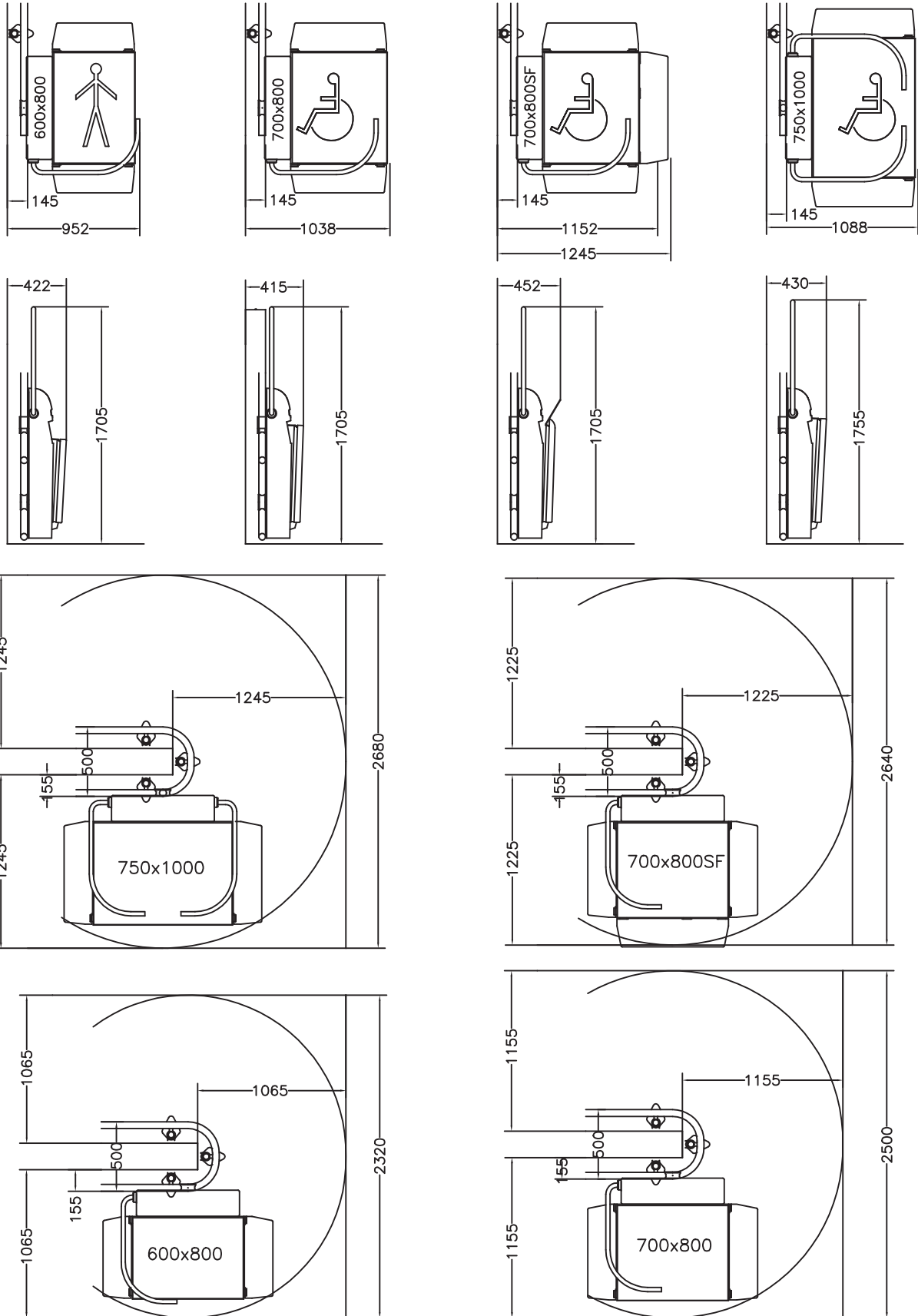

Stepper

 schemi principali
  main diagrams
  esquemas principal
  schémas principaux
  Standardabmessungen



 disegni fuori scala - quote in millimetri

 drawings not to scale - measures in millimetres

 diseños no en escala - medidas en milímetros

 dessins non à l'échelle - dimensions en millimètres

 Zeichnungen nicht Massstabsgerecht - Maßangabe in Millimeter

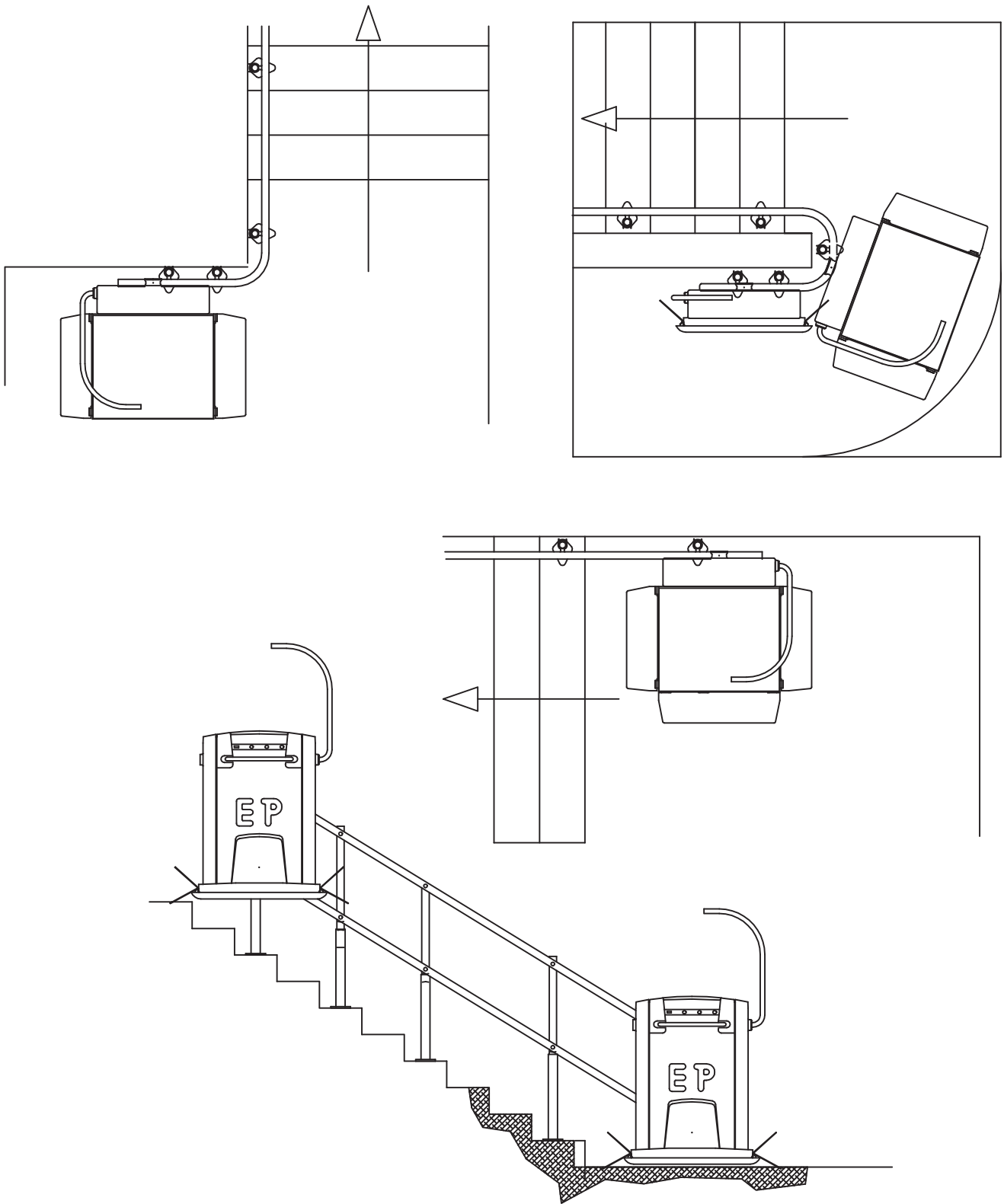

 disegni fuori scala - quote in millimetri

 drawings not to scale - measures in millimetres

 diseños no en escala - medidas en milímetros

 dessins non à l'échelle - dimensions en millimètres

 Zeichnungen nicht Masstabgerecht - Maßangabe in Millimeter